

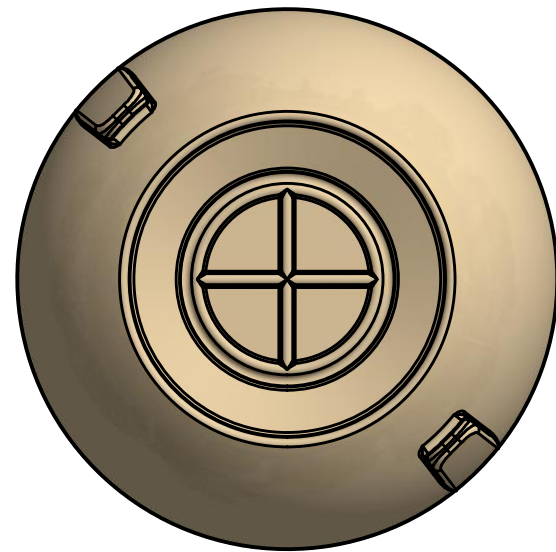

20" LID
(HAZARDOUS GAS WARNING)

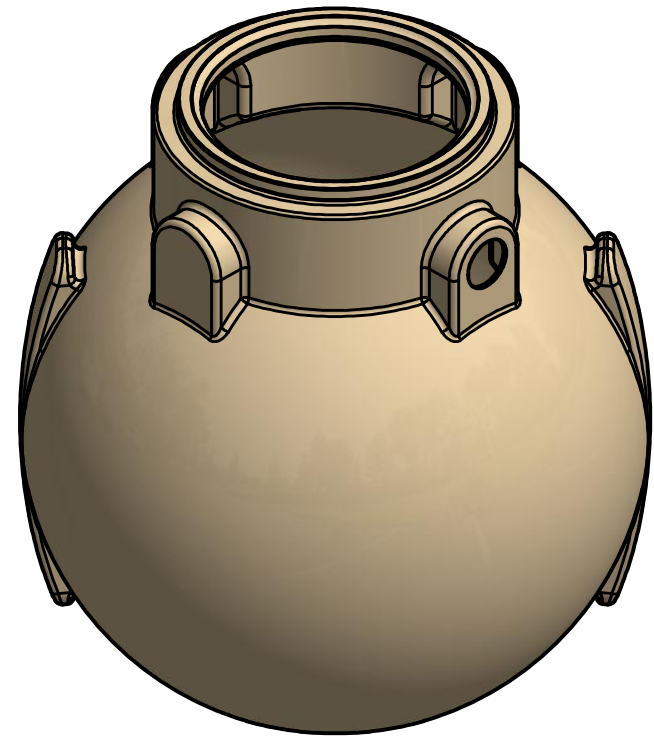

ASTM 923 GASKET

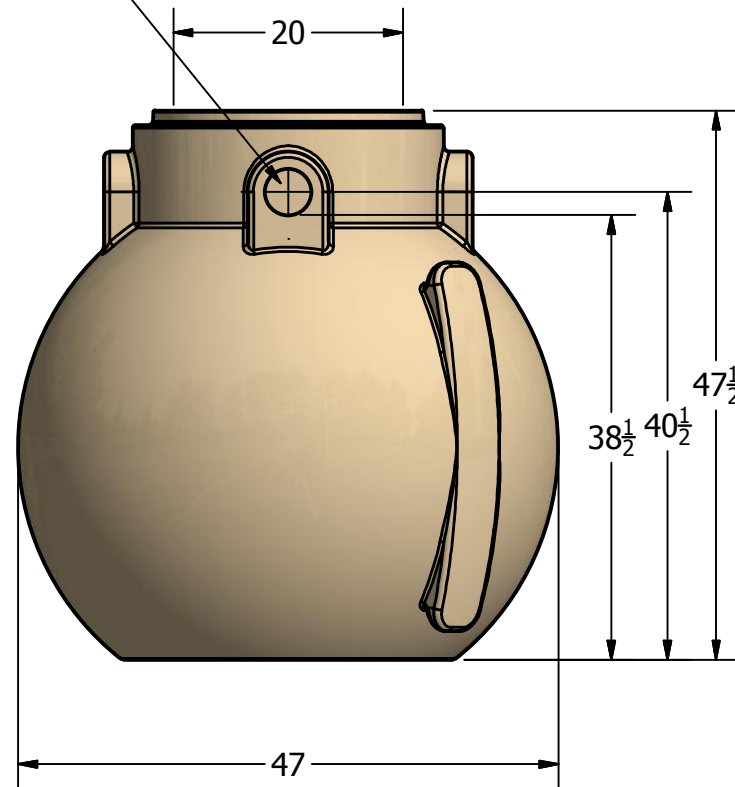

DRAWN	bolzer	8/12/2016		
CHECKED			NORWESCO, INC. SAINT BONIFACIUS, MN TITLE	
QA			225 LOW PROFILE PUMP (FL)	
MFG				
APPROVED				
			SIZE B	DWG NO 43551
			SCALE: 1/16	REV SHEET 1 OF 2

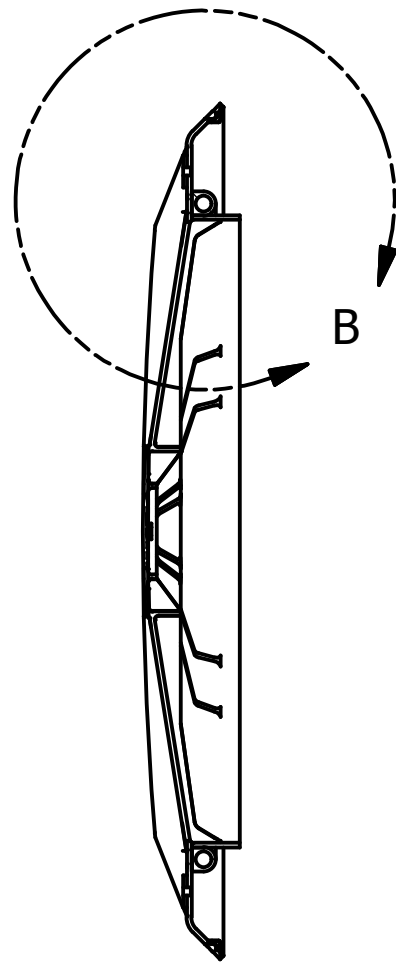
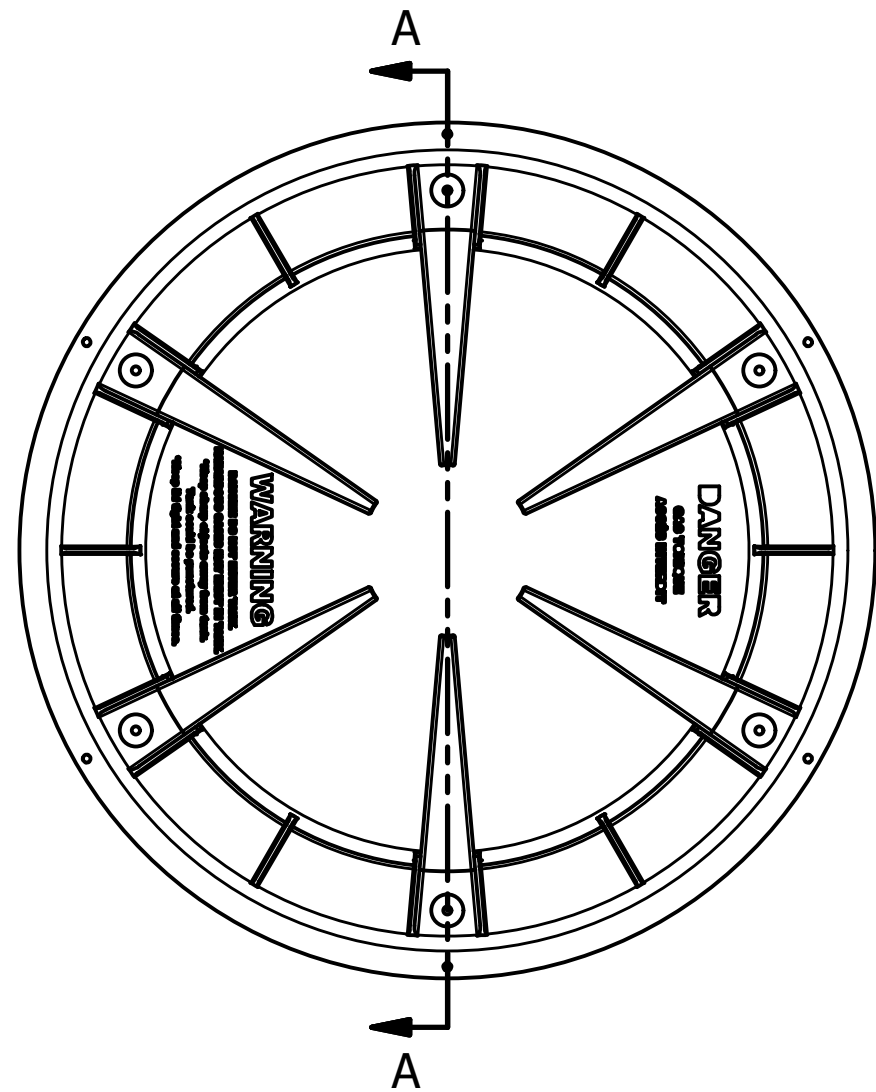

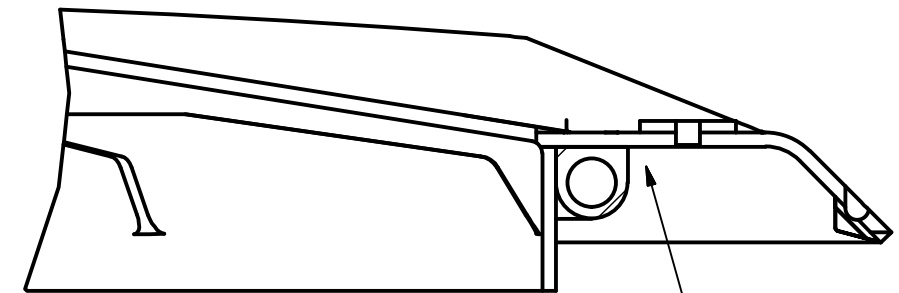

SECTION A-A
SCALE 1 / 6

DETAIL B
SCALE 1 / 2

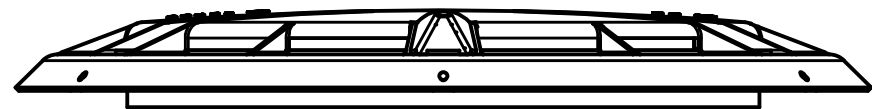

INSTALL WITH FLAT PORTION
OF GASKET ATTACHED TO THE HORIZONTAL
FLAT SURFACE OF THE LID AS SHOWN



DRAWN bolzer	8/12/2016	 NORWESCO, INC. SAINT BONIFACIUS, MN TITLE		
CHECKED				
QA		225 LOW PROFILE PUMP (FL)		
MFG				
APPROVED		SIZE B	DWG NO 43551	REV
		SCALE: 1/16	SHEET 2 OF 2	